

Rueda corredera "ECO" soporte soldar $\varnothing 80$ canal 20

Rueda R-20 S/Soldar - Zinc
ACERO F-114

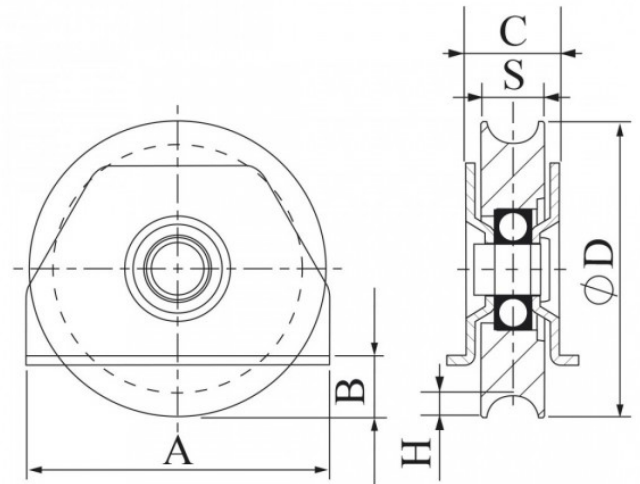

Referencia	\varnothing (D)	Ancho	Carga	Acabado	A	B	C	H	S	R
24080	80	32	600	Zinc	80	19,8	33	9,3	24	20,6

Fabricación según norma UNE-EN 13241-1-2004